

# YAMAHA RX-V1050 RS

5 Channel Amplifier Configuration

110W + 110W (8Ω) RMS Output Power, 0.015% THD, 20-20,000 Hz (Front)

110W (8Ω) RMS Output Power, 0.015% THD, 20-20,000 Hz (Center)

30W + 30W (8Ω) RMS Output Power, 0.08% THD, 1,000 Hz (Rear)

Digital Sound Field Processor; 4 Programs for Digital Sound Field Processing and 2 Programs for the Dolby Surround (DOLBY PRO LOGIC and ENHANCED)

Automatic Input Balance Control Function for the Dolby Surround

Video Signal Input/Output Capability (Adaptable for S VIDEO Connections)

40-Station Random Preset Tuning

Bass Extension Switch

SLEEP Timer

Programmable Remote Control Transmitter

Thank you for selecting the YAMAHA stereo receiver.



## CONTENTS

Safety Instructions .....	2
Caution .....	3
Supplied Accessories .....	3
Open/Close the Control Door .....	3
Profile of This Unit .....	4
Speaker Setting-up for This Unit .....	5
Connections .....	6
Adjustment Before Operation .....	10
Operations .....	13
Tuning Operations .....	15
Using Digital Sound Field Processor (DSP) .....	17
Setting of the SLEEP Timer .....	21
Remote-Control Transmitter .....	22
Remote-Control "Learning" Function .....	23
Notes about the Remote Control Transmitter .....	24
Troubleshooting .....	25
Specifications .....	26

### IMPORTANT!

Please record the serial number of this unit in the space below.

Model:  
Serial No.:

The serial number is located on the rear of the unit.  
Retain this Owner's Manual in a safe place for future reference.

### WARNING

TO REDUCE THE RISK OF FIRE OR ELECTRIC SHOCK, DO NOT EXPOSE THIS UNIT TO RAIN OR MOISTURE.

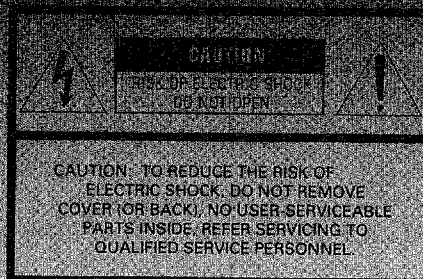

#### • Explanation of Graphical Symbols



The lightning flash with arrowhead symbol, within an equilateral triangle, is intended to alert you to the presence of uninsulated "dangerous voltage" within the product's enclosure that may be of sufficient magnitude to constitute a risk of electric shock to persons.



The exclamation point within an equilateral triangle is intended to alert you to the presence of important operating and maintenance (servicing) instructions in the literature accompanying the appliance.

# SAFETY INSTRUCTIONS

- 1 Read Instructions – All the safety and operating instructions should be read before the unit is operated.
- 2 Retain Instructions – The safety and operating instructions should be retained for future reference.
- 3 Heed Warnings – All warnings on the unit and in the operating instructions should be adhered to.
- 4 Follow Instructions – All operating and other instructions should be followed.
- 5 Water and Moisture – The unit should not be used near water – for example, near a bathtub, washbowl, kitchen sink, laundry tub, in a wet basement, or near a swimming pool, etc.
- 6 Carts and Stands – The unit should be used only with a cart or stand that is recommended by the manufacturer.
- 6A A unit and cart combination should be moved with care. Quick stops, excessive force, and uneven surfaces may cause the unit and cart combination to overturn. 
- 7 Wall or Ceiling Mounting – The unit should be mounted to a wall or ceiling only as recommended by the manufacturer.
- 8 Ventilation – The unit should be situated so that its location or position does not interfere with its proper ventilation. For example, the unit should not be situated on a bed, sofa, rug, or similar surface, that may block the ventilation openings; or placed in a built-in installation, such as a bookcase or cabinet that may impede the flow of air through the ventilation openings.
- 9 Heat – The unit should be situated away from heat sources such as radiators, stoves, or other appliances that produce heat.
- 10 Power Sources – The unit should be connected to a power supply only of the type described in the operating instructions or as marked on the unit.
- 11 Power-Cord Protection – Power-supply cords should be routed so that they are not likely to be walked on or pinched by items placed upon or against them, paying particular attention to cords at plugs, convenience receptacles, and the point where they exit from the unit.
- 12 Cleaning – The unit should be cleaned only as recommended by the manufacturer.
- 13 Nonuse Periods – The power cord of the unit should be unplugged from the outlet when left unused for a long period of time.
- 14 Object and Liquid Entry – Care should be taken so that objects do not fall into and liquids are not spilled into the inside of the unit.
- 15 Damage Requiring Service – The unit should be serviced by qualified service personnel when:
  - A. The power-supply cord or the plug has been damaged; or
  - B. Objects have fallen, or liquid has been spilled into the unit; or
  - C. The unit has been exposed to rain; or
  - D. The unit does not appear to operate normally or exhibits a marked change in performance; or
  - E. The unit has been dropped, or the cabinet damaged.
- 16 Servicing – The user should not attempt to service the unit beyond those means described in the operating instructions. All other servicing should be referred to qualified service personnel.
- 17 Power Lines – An outdoor antenna should be located away from power lines.
- 18 Grounding or Polarization – Precautions should be taken so that the grounding or polarization is not defeated.

- 19 Outdoor Antenna Grounding – If an outside antenna is connected to this unit, be sure the antenna system is grounded so as to provide some protection against voltage surges and built-up static charges. Article 810 of the National Electrical Code, ANSI/NFPA 70, provides information with regard to proper grounding of the mast and supporting structure, grounding of the lead-in wire to an antenna discharge unit, size of grounding conductors, location of antenna discharge unit, connection to grounding electrodes, and requirements for the grounding electrode.

EXAMPLE OF ANTENNA GROUNDING

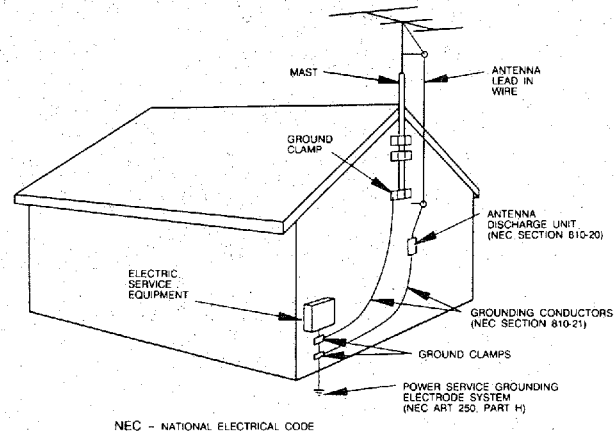

### Note to CATV system installer:

This reminder is provided to call the CATV system installer's attention to Article 820-40 of the NEC that provides guidelines for proper grounding and, in particular, specifies that the cable ground shall be connected to the grounding system of the building, as close to the point of cable entry as practical.

### CAUTION: READ THIS BEFORE OPERATING YOUR UNIT

- 1 To ensure the finest performance, please read this manual carefully. Keep it in a safe place for future reference.
- 2 Install your unit in a cool, dry, clean place – away from windows, heat sources, and too much vibration, dust, moisture or cold. Avoid sources of hum (transformers, motors). To prevent fire or electrical shock, do not expose to rain and water.
- 3 Do not operate the unit upside-down. It may overheat, possibly causing damage.
- 4 Never open the cabinet. If a foreign object drops into the set, contact your dealer.
- 5 Do not use force on switches, knobs or cords. When moving the set, first turn the unit off. Then gently disconnect the power plug and the cords connecting to other equipment. Never pull the cord itself.
- 6 Do not attempt to clean the unit with chemical solvents; this might damage the finish. Use a clean, dry cloth.
- 7 Always set the volume control to “-∞” before starting the audio source play: increase the volume gradually to an appropriate level after the play is started.
- 8 To prevent lightning damage, pull out the power cord and remove the antenna cable during an electrical storm.

9 Be sure to read the "Troubleshooting" section on common operating errors before concluding that your unit is faulty.

10 Do not connect audio equipment to the AC outlets on the rear panel if that equipment requires more power than the outlets are rated to provide.

### FCC INFORMATION

**1. IMPORTANT NOTICE : DO NOT MODIFY THIS UNIT!**

This product, when installed as indicated in the instructions contained in this manual, meets FCC requirements. Modifications not expressly approved by Yamaha may void your authority, granted by the FCC, to use the product.

**2. IMPORTANT :** When connecting this product to accessories and/or another product use only high quality shielded cables. Cable/s supplied with this product **MUST** be used. Follow all installation instructions. Failure to follow instructions could void your FCC authorization to use this product in the USA.

**3. NOTE :** This product has been tested and found to comply with the requirements listed in FCC Regulations, Part 15 for Class "B" digital devices. Compliance with these requirements provides a reasonable level of assurance that your use of this product in a residential environment will not result in harmful interference with other electronic devices.

This equipment generates/uses radio frequencies and, if not installed and used according to the instructions found in the users manual, may cause interference harmful to the operation of other electronic devices.

Compliance with FCC regulations does not guarantee that interference will not occur in all installations. If this product is found to be the source of interference, which can be determined by turning the unit "OFF" and "ON", please try to eliminate the problem by using one of the following measures:

Relocate either this product or the device that is being affected by the interference.

Utilize power outlets that are on different branch (circuit breaker or fuse) circuits or install AC line filter/s.

In the case of radio or TV interference, relocate/reorient the antenna. If the antenna lead-in is 300 ohm ribbon lead, change the lead-in to co-axial type cable.

If these corrective measures do not produce satisfactory results, please contact the local retailer authorized to distribute this type of product. If you can not locate the appropriate retailer, please contact Yamaha Electronics Corp., U.S.A. 6660 Orangethorpe Ave, Buena Park, CA 90620.

The above statements apply **ONLY** to those products distributed by Yamaha Corporation of America or its subsidiaries.

## We Want You Listening For A Lifetime

YAMAHA and the Electronic Industries Association's Consumer Electronics Group want you to get the most out of your equipment by playing it at a safe level. One that lets the sound come through loud and clear without annoying blaring or distortion – and, most importantly, without affecting your sensitive hearing. Since hearing damage from loud sounds is

often undetectable until it is too late, YAMAHA and the Electronic Industries Association's Consumer Electronics Group recommend you to avoid prolonged exposure from excessive volume levels.



### SUPPLIED ACCESSORIES

After unpacking, check that the following parts are contained.

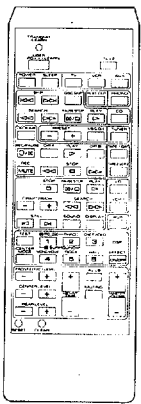

Remote Control Transmitter

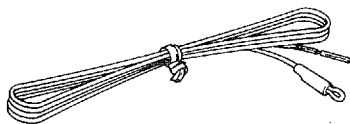

Indoor FM Antenna

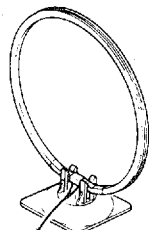

AM Loop Antenna

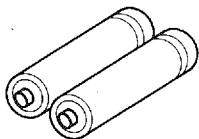

Batteries (size "AA", LR6)

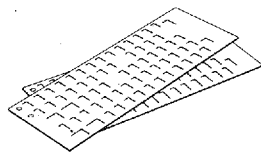

User Program Sheets

### OPEN/CLOSE THE CONTROL DOOR

When it is not necessary to operate controls inside the control door, close the door.

To close the door

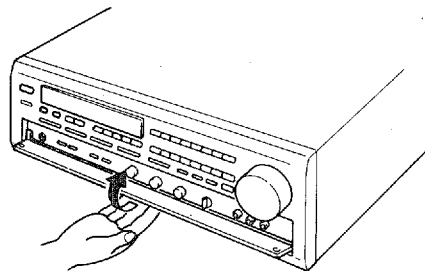

To open the door

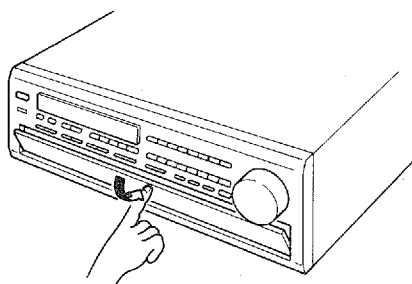

## PROFILE OF THIS UNIT

You are the proud owner of Yamaha RX-V1050, the stereo receiver –an extremely sophisticated audio component. The Digital Sound Field Processor (DSP) built in this unit takes full advantage of Yamaha's undisputed leadership in the field of digital audio processing to bring you a whole new world of listening experiences. Follow the instructions in this manual carefully when setting up your system, and this unit will sonically transform your room into a wide range of listening environments –anything from a famous concert hall to a live house. In addition, you get incredible realism from Dolby-encoded video sources using the built-in Dolby Pro Logic Surround Decoder.

Five built-in channels of amplification on this unit mean that no additional amplifiers are required to enjoy advanced digital sound field processing.

Rather than tell you about the wonders of digital sound field processing, however, let's get right down to the business of setting up the system and trying out its many capabilities. Please read this operation manual carefully and store it in a safe place for later reference.

### Digital Sound Field Processing

---

What is it that makes live music so good? Today's advanced sound reproduction technology lets you get extremely close to the sound of a live performance, but chances are you'll still notice something missing: the acoustic environment of the live concert hall. Extensive research into the exact nature of the sonic reflections that create the ambience of a large hall has made it possible for Yamaha engineers to bring you this same sound in your own listening room, so you'll feel all the sound of a live concert.

What's more, our technicians, armed with sophisticated measuring equipment, have even made it possible to capture the acoustics of a variety of actual concert hall, theater, etc. to allow you to accurately recreate one of several actual live performance environments, all in your own home.

### Dolby Pro Logic Surround

---

The Dolby Pro Logic Surround Decoder program lets you experience the dramatic realism and impact of Dolby Surround movie theater sound in your own home. Dolby Pro Logic gets its name from its professional-grade steering logic circuitry, which provides greater effective channel separation for a much higher degree of realism than the "passive" Dolby Surround circuits found in today's typical home audio/video equipment. Dolby Pro Logic Surround provides a true center channel, so that there are four independent channels, unlike passive Dolby Surround which has in effect only three channels: left, right, and rear. This center channel allows listeners seated in even less-than-ideal positions to hear the dialog originating from action on the screen while getting a stereo effect as well.

This Dolby Pro Logic Surround Decoder employs a digital signal processing system. This system increases sound stability at each channel and minimizes crosstalk between channels, compared to conventional analog Dolby signal processing.

In addition, this unit features a built-in automatic input balance control. This circuit always presents you the best surround conditions without performing manual adjustments.

### "ENHANCED" Dolby Pro Logic Surround

---

The RX-V1050 has a second mode of Dolby Pro Logic Surround processing called "Enhanced Dolby Pro Logic Surround" processing. Enhanced Dolby Pro Logic Surround processing recreates the surround effect of a movie theater, effectively duplicating their multiple surround loudspeaker system, completely surrounding the listener with the sounds of the action taking place on the screen.

# SPEAKER SETTING UP FOR THIS UNIT

## SPEAKERS TO BE USED

This unit is designed to provide the best sound-field quality with 5 speakers configuration. The speakers to be used with this unit will be mainly front speakers, rear speakers, and a center speaker. (You can delete a center speaker. Refer to the "4-Speakers Configuration" shown below.)

The front speakers are used for the output of the main source sound and the effect sound. They will probably be your present stereo speaker system. The rear speakers are used for the output of the effect sound. And the center speaker is used for the output of the dialogue or sound encoded with the Dolby Surround. The rear and center speakers do not need to be of such high quality. However, all the speakers should have high enough power handling to accept the maximum output of this unit that will drive them.

It is also possible to further expand your system with the addition of a subwoofer and amplifier. You may wish to choose the convenience of a Yamaha Active Servo Processing Subwoofer System which has its own built-in power amp.

## SPEAKERS CONFIGURATION

### 5-Speakers Configuration

This configuration is the most effective and recommended. In this configuration, the center speaker is necessary as well as the rear speakers. If the digital sound field program is in the **DOLBY PRO LOGIC** or **ENHANCED**, conversations will be output from the center speaker and the ambience will be excellent.

- Set the center mode to the "NORMAL" or "WIDE" position. (For details, refer to the page 11.)

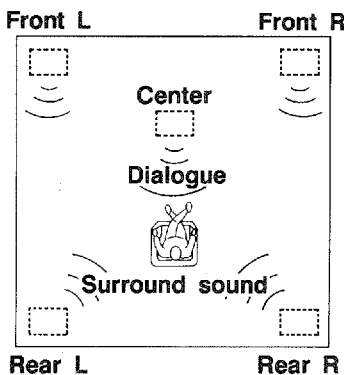

### 4-Speakers Configuration

The center speaker is not used in this configuration. If the digital sound field program is in the **DOLBY PRO LOGIC** or **ENHANCED**, the center speaker sound is output from the left and the right front speakers. However, the sound effect of other programs can be the same as that of the 5-speakers configuration.

- Be sure to set the center mode to the "PHANTOM" position. (For details, refer to the page 11.)

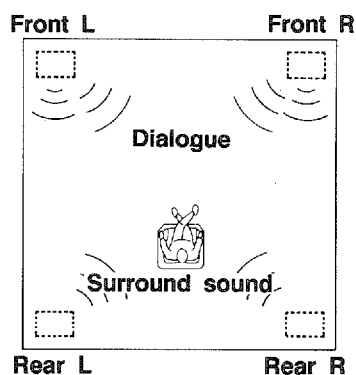

## SPEAKER PLACEMENT

The recommended speaker configuration, the 5-speaker configuration, will require two speaker pairs: **front speakers** (your normal stereo speakers), and **rear speakers**, plus a **center speaker**. You may also be using a subwoofer. When you place these speakers, refer to the following.

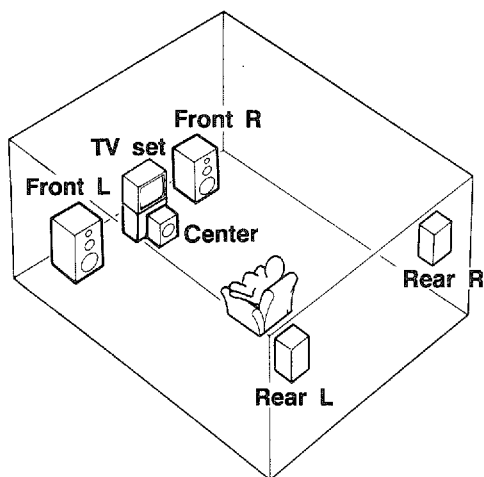

- Front:** In normal position. (The position of your present stereo speaker system.)
- Rear:** Behind your listening position, facing slightly inward. Nearly six feet up from the floor.
- Center:** Precisely between the front speakers. (To avoid interference to TV sets, use a magnetically shielded speaker. If, however, it is not effective, keep the speaker away from TV sets.)

- \* If you use a subwoofer, the position of the speaker is not so critical because low bass tones are not highly directional.

# CONNECTIONS

Before attempting to make any connections to or from this unit, be sure to first switch OFF the power to this unit and to any other components to which connections are being made.

## CONNECTIONS WITH OTHER COMPONENTS

When making connections between this unit and other components, be sure all connections are made correctly, that is to say L (left) to L, R (right) to R, "+" to "+" and "-" to "-". Also, refer to the owner's manual for each component to be connected to this unit.

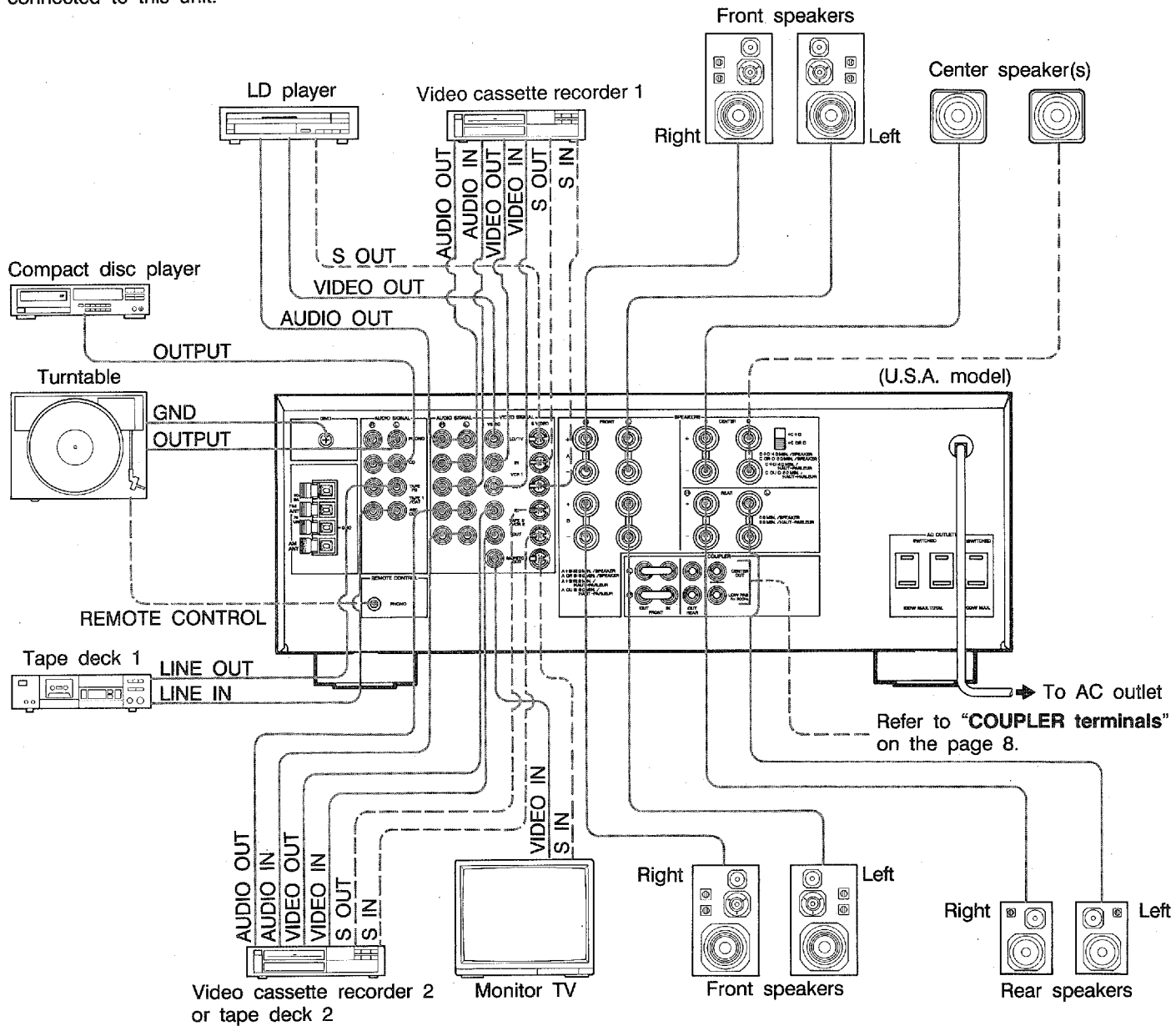

## USING AUX TERMINALS (ON THE FRONT PANEL)

These terminals are used to connect an auxiliary video input source such as a camcorder to this unit.

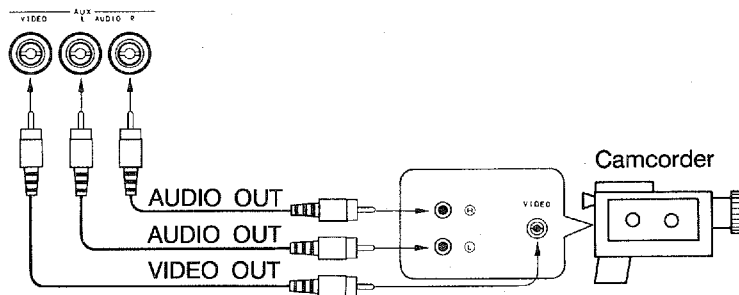

## CONNECTING SPEAKERS

Connect the **SPEAKERS** terminals to your speakers with wire of the proper gauge, cut to be as short as possible. If the connections are faulty, no sound will be heard from the speakers. Make sure that the polarity of the speaker wires is correct, that is, + and - markings are observed. If these wires are reversed, the sound will be unnatural and will lack bass. **Do not let the bare speaker wires touch each other and do not let them touch the metal parts of this unit as this could damage this unit and/or speakers.**

- Use speakers with the specified impedance shown on the rear of this unit.

### How to Connect:

Red: positive (+)  
Black: negative (-)

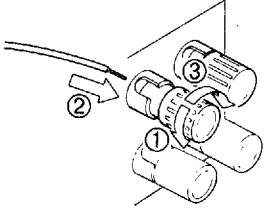

- ① Unscrew the knob.
- ② Insert the bare wire.
- ③ Tighten the knob and secure the wire.

### Front speaker connection:

One or two speaker systems can be connected to this unit. If you connect only one speaker system, connect it to either the **FRONT A** or **B** terminals.

### Rear speaker connection:

One rear speaker system can be connected to the **REAR** terminals.

### Center speaker connection:

One or two center speakers can be connected to this unit. If you connect only one center speaker, connect it to either the **CENTER C** or **D** terminals.

While connecting, be sure to set the **CENTER** speaker impedance switch to the proper position.

Set to "**C+D**" when using two center speakers, or to "**C OR D**" when using only one center speaker. If the switch is set to the improper position, no sound may be heard from the center speaker.

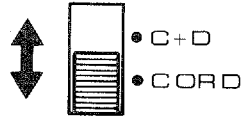

## CONNECTING S VIDEO TERMINALS

If your video cassette recorder, video disc player, etc. and your monitor are equipped with "S" (high-resolution) video terminals, connect them to this unit's S-VIDEO terminals, and connect this unit's S-VIDEO MONITOR OUT terminal to the "S" video input of your monitor. Otherwise, connect the composite video terminals from your video cassette recorder, video disc player, etc. to the VIDEO terminals of this unit, and connect this unit's VIDEO MONITOR OUT terminal to the composite video input of your monitor.

### Note

If video signals are sent to both S-VIDEO input and VIDEO input terminals, the signals will be sent to their respective output terminals independently.

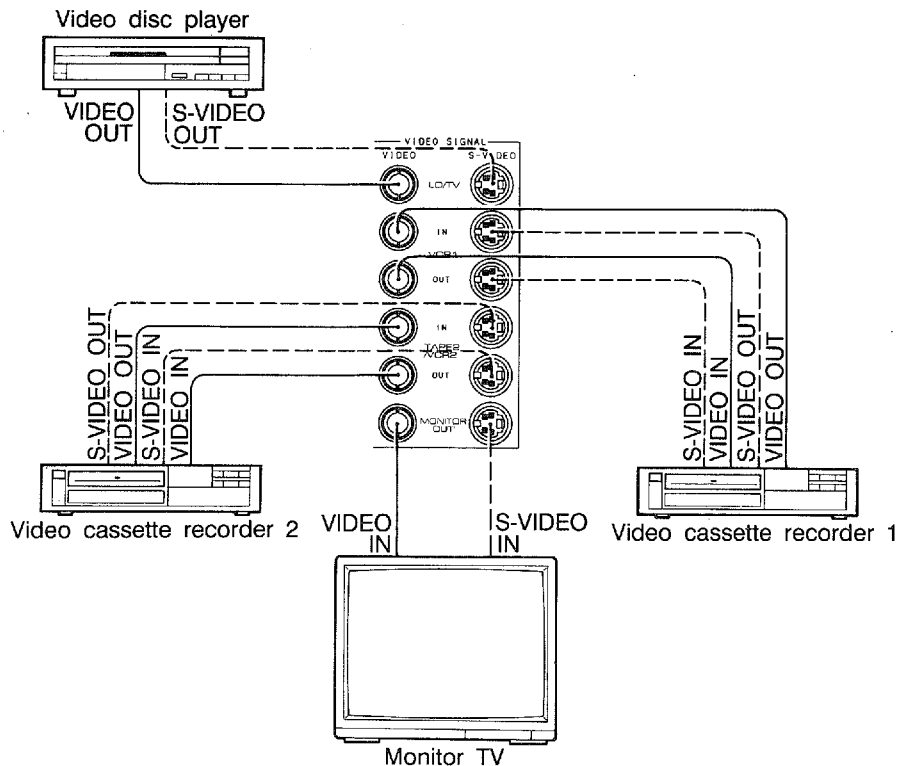



# ABOUT THE ACCESSORY TERMINALS

## AC OUTLETS

(U.S.A., Canada and General models)  
 .....2 SWITCHED OUTLETS and 1 UNSWITCHED OUTLET  
 (Australia model) ..... 1 SWITCHED OUTLET

Use these to connect the power cords from your components to this unit.  
 The power to the **SWITCHED** outlets is controlled by this unit's **POWER** switch or the provided remote-control transmitter's **POWER** key. These outlets will supply power to any component whenever this unit is turned on.  
 The power to the **UNSWITCHED** outlet can not be controlled by this unit's **POWER** switch or the provided remote-control transmitter's **POWER** key.

<U.S.A. and General models>  
 The maximum power (total power consumption of components) that can be connected to the **SWITCHED AC OUTLETS** is 100 watts.  
 The maximum power (total power consumption of components) that can be connected to the **UNSWITCHED AC OUTLET** is 200 watts.

<Canada model>  
 The maximum power (total power consumption of components) that can be connected to the **SWITCHED AC OUTLETS** is 120 watts.  
 The maximum power (total power consumption of components) that can be connected to the **UNSWITCHED AC OUTLET** is 180 watts.

<Australia model>  
 The maximum power (total power consumption of components) that can be connected to the **SWITCHED AC OUTLET** is 100 watts.

## REMOTE CONTROL (PHONO) connector

If you have a YAMAHA turntable with the **RS** mark, connect it to this connector by using the cable provided with the turn table. This connection allows you to control the turntable from the provided remote-control transmitter.

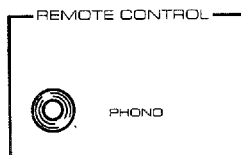

## GND terminal (For turntable use)

Connecting the ground wire of the turntable to this terminal will minimize hum, but in some cases better results may be obtained with the ground wire disconnected.

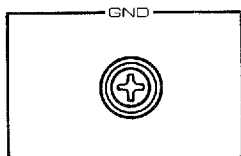

## COUPLER terminals

### FRONT OUT terminals

These terminals are for front-channel line output. Leave the jumper bars connected to **FRONT IN** terminals when you use the built-in amplifier.  
 However, if you drive front speakers with an external stereo power amplifier, remove the jumper bars and connect input terminals of the external amplifier (**MAIN IN** or **AUX** terminals of a power amplifier or an integrated amplifier) to these terminals.

### FRONT IN terminals

These terminals are for line input to the built-in front-channel amplifier. Leave the jumper bars connected to **FRONT OUT** terminals when you use the built-in amplifier.  
 However, if you drive front speakers with an external stereo power amplifier, remove the jumper bars.

### REAR OUT terminals

These terminals are for rear-channel line output. If you use the built-in amplifier, there is no connection to these terminals.  
 However, if you drive rear speakers with an external stereo power amplifier, connect input terminals of the external amplifier to these terminals.  
 If you connect the built-in amplifier and the external power amplifier at the same time, the sound will be output only through the external one.

### CENTER OUT terminal

This terminal is for center-channel line output. There is no connection to this terminal when you use the built-in amplifier.  
 However, if you drive a center speaker with an external power amplifier, connect input terminal of the external amplifier to this terminal.  
 If you connect the built-in amplifier and the external power amplifier at the same time, the sound will be output only through the external one.

### LOW PASS terminal

This terminal is for output to a mono amplifier driving a subwoofer. Frequencies above 200 Hz are filtered out so that only the bass range remains.

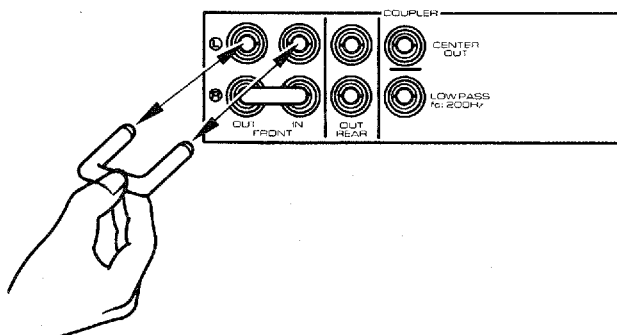



## ANTENNA CONNECTIONS

- Each antenna should be connected to the designated terminals correctly, referring to the following figure.
- Both AM and FM indoor antennas are included with this unit. In general, these antennas will probably provide sufficient sensitivity. Furthermore, a properly installed outdoor antenna will give clearer reception than an indoor one. If you experience poor reception quality, an outdoor antenna may result in improvement.

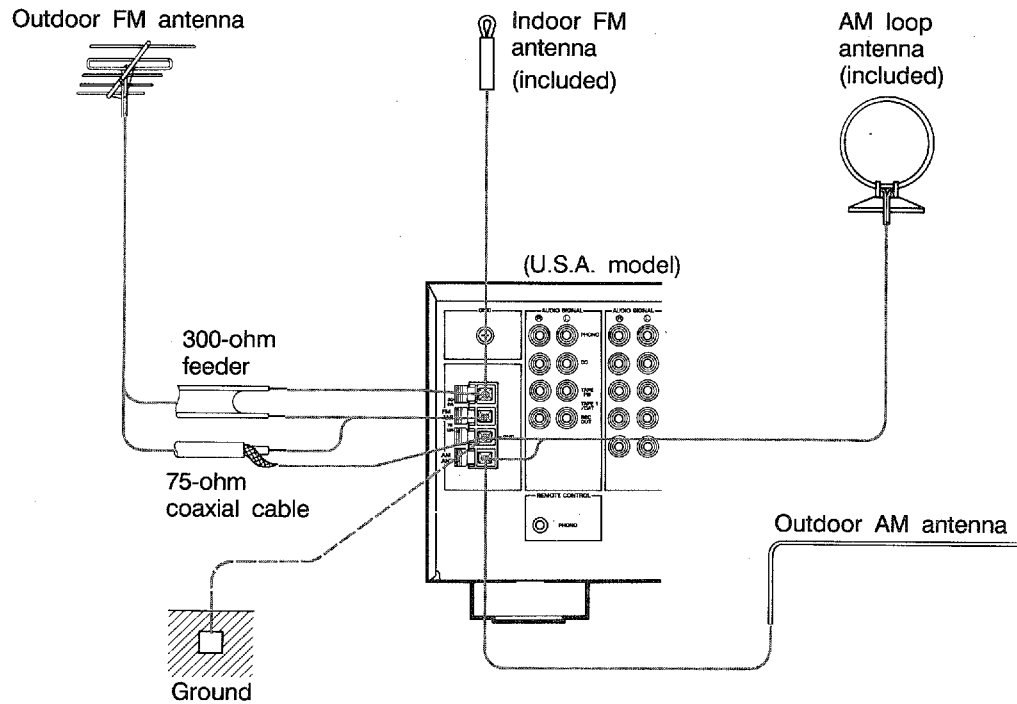

### Connecting the AM loop antenna

1

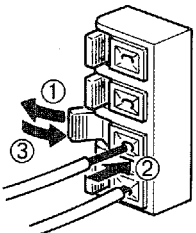

2

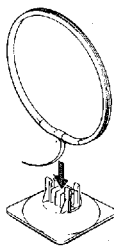

3

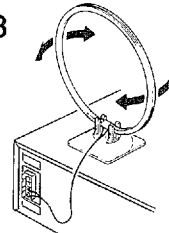

Orient so that the best reception is obtained.

\* The antenna may be hung on a wall.

\* The AM loop antenna should be kept being connected, even if an outdoor AM antenna is connected to this unit.

### GND terminal

For maximum safety and minimum interference, connect the **GND** terminal to a good earth ground if practical. A good earth ground is a metal stake driven into moist earth.

### Notes

- If you need an outdoor FM antenna to improve FM reception quality, either 300-ohm feeder or coaxial cable may be used. In locations troubled by electrical interference, coaxial cable is preferable.

# ADJUSTMENT BEFORE OPERATION

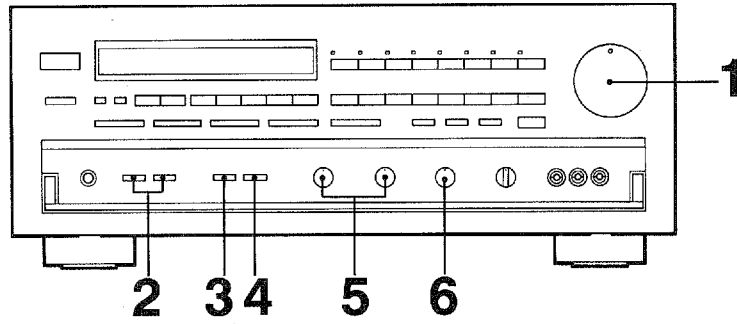

## Speaker balance adjustment

Using the built-in test tone generator, this procedure lets you adjust the sound output level balance between the front, center, and rear speakers. With this adjustment, the sound output level heard at the listening position will be the same from each speaker. This is important for the best performance of digital sound field processor.

**1**

VOLUME

Set to the "∞" position.

---

**2** Select the front speakers to be used.

SPEAKERS

A ON B ON

OFF OFF

\* If you use two front speaker systems, press both the A and B switches.

---

**3**

BASS EXTENSION

ON OFF

→ OFF

---

**4**

TONE BYPASS

ON OFF

→ OFF

**5**

BASS DEFEAT TREBLE DEFEAT

Set to the "DEFEAT" position.

---

**6**

BALANCE

Set to the "0" position.

From the step 7, the adjustment should be done with the remote-control transmitter at your listening position. (The adjustment can be done also with the front panel of this unit. However, the result may not be excellent.)

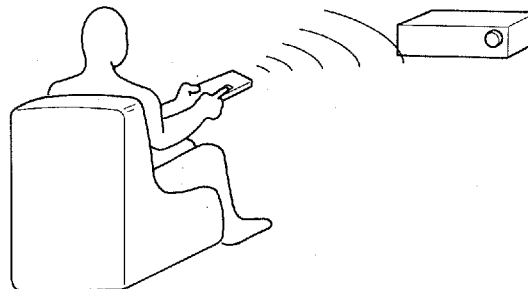

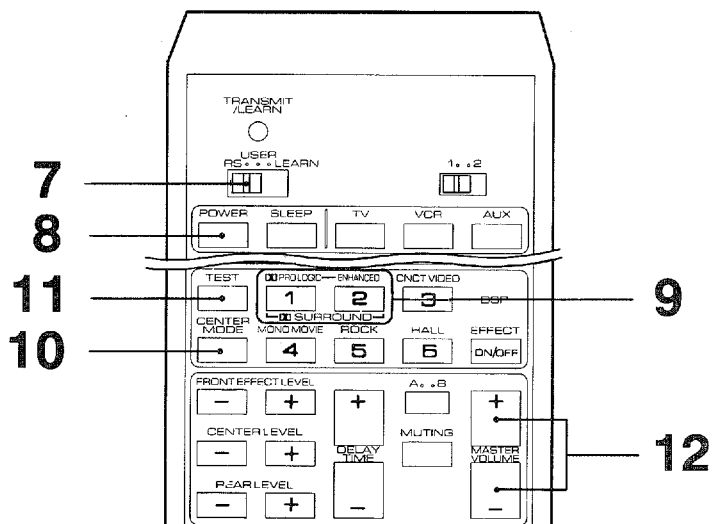

For the detailed informations on the remote-control transmitter, refer to "REMOTE-CONTROL TRANSMITTER" on the page 22.

**7**

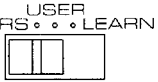

Set to the "RS" position.

---

**8**

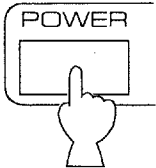

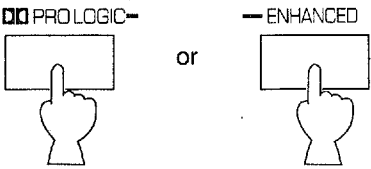

---

**9**

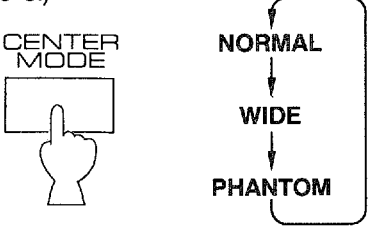

---

**10** Select the center mode depending on your speaker configuration. (Refer to "SPEAKERS CONFIGURATION" on the page 5.)



On the feature of each mode, refer to the "Note" shown below.

---

**11**

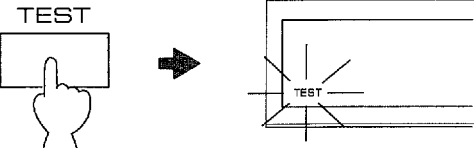

Flashes on and off continuously.

**12** Turn up the **VOLUME** by using the remote-control transmitter. You will hear a test tone (like pink noise) from the left front speaker, then the center speaker, then the right front speaker, then the rear speakers, for about two seconds each. The display illumination changes as shown below.

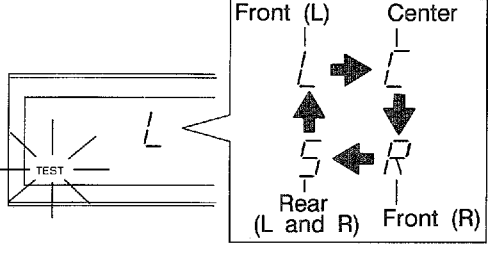

\* The test tone from the left rear speaker and the right rear speaker will be heard at the same time.

**Note**

- In the step 10, when you select the center mode, note the following.
  - For 5 speakers configuration
    - NORMAL**: Select this mode when you use the center speaker smaller sized than the front speakers. In this mode, the bass tone will be output from the front speakers.
    - WIDE**: Select this mode when you use the center speaker approximately same sized as the front speakers.
  - For 4 speakers configuration
    - PHANTOM**: Select this mode when you do not use the center speaker. The center speaker sound will be output from the left and the right front speakers.

This key does not function if the unit is in the **TEST** mode. Because the effect sound output level of the front speakers is used as the basis in speaker balance adjustment.

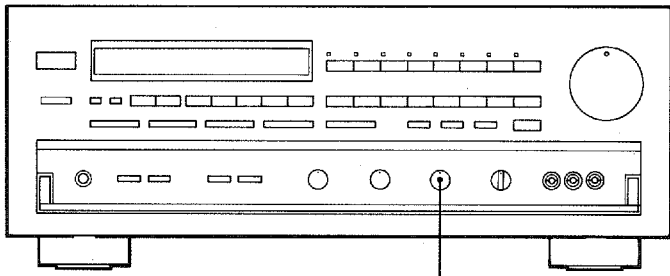

13

**13** Adjust the **BALANCE** control so that the effect sound output level of the left front speaker and the right front speaker are the same.

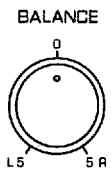

On the inside panel of the unit.

**14** Make the sound output level of the center speaker the same as that of the front speakers with the **CENTER LEVEL** key.

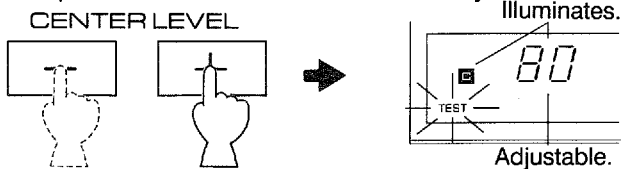

Adjustable.

**15** Make the sound output level of the rear speakers the same as that of the front speakers with the **REAR LEVEL** key.

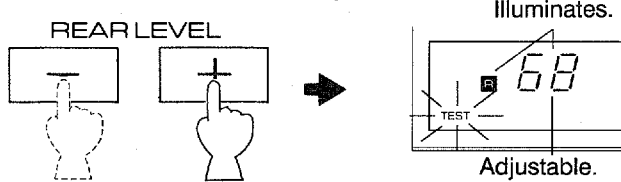

Adjustable.

16

14  
15

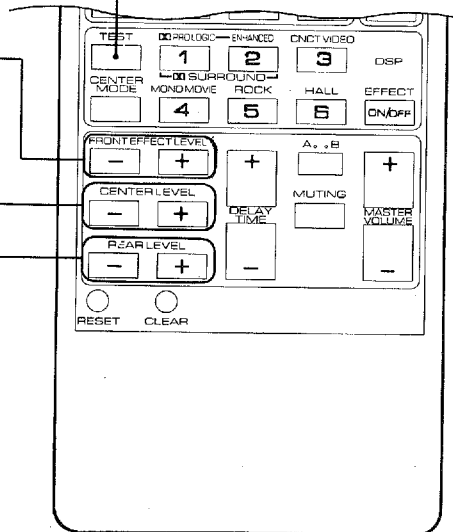

16

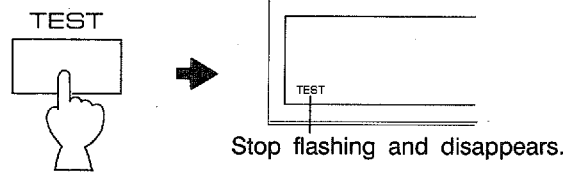

Stop flashing and disappears.

**Notes**

- Once you have completed these adjustments, use only this unit's **VOLUME** control to adjust listening volume. Do not change any other volume settings in this unit.
- If you use external power amplifiers, their volume controls may also be adjusted to achieve proper balance.
- In the step 14, if the center mode is in the "PHANTOM", the sound output level of the center speaker can not be adjusted. Because in this mode, the center speaker sound is automatically output from the left and right front speakers.

# OPERATIONS

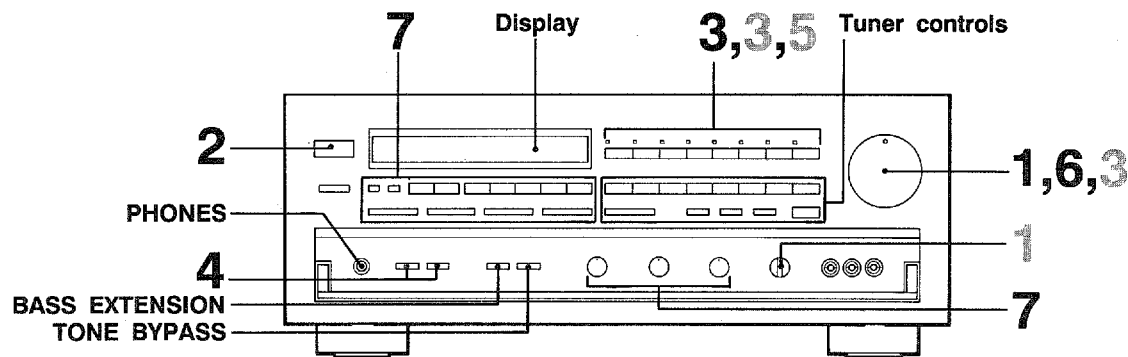

## To play a source

- 1**

Set to the "∞" position.
- 2**
- 3** Select a desired input source.  
(For video sources, turn the TV/monitor ON.)

AUX VCR1 LD/TV TAPE2/VCR2 TAPE1/DAT TUNER CD PHONO
- 4** Select the front speakers to be used.

SPEAKERS

\* If you use two front speaker systems, press both the A and B switches.
- 5** Play the source. (For detailed informations on the tuning operation, refer to the page 15.)
- 6**

Adjust to the desired output level.

**7** If desired, adjust the **BASS**, **TREBLE**, **BALANCE** controls, etc. and use the digital sound field processor. (For details, refer to "USING DIGITAL SOUND FIELD PROCESSOR (DSP)" on the page 17.)

## To record a source to tape (or dub from a tape to another)

- 1** Select the source to be recorded.
- 2** Play the source.
- 3** Confirm the source by selecting it with the **INPUT** selector and turning up the **VOLUME** control.
- 4** Set the tape deck (or VCR) in the recording mode.
- 5** If your tape deck has three head monitoring capability you can monitor the signal just recorded by selecting the tape deck in the recording mode with the input selector.

\* Also, refer to the manual of the tape deck being used.

### Notes

- If you want to enjoy another source while recording, select it with the **INPUT** selector.
- Adjusting the **VOLUME**, **BASS**, **TREBLE**, **BALANCE** controls, **BASS EXTENSION** and **TONE BYPASS** switch and operating the digital sound field processor during recording have no effect on the material being recorded.

### Adjusting the BALANCE control

Adjust the balance of the output volume to the left and right speakers to compensate for sound imbalance caused from the speaker settings or the listening room condition.

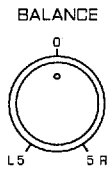

### Adjusting the BASS and TREBLE controls

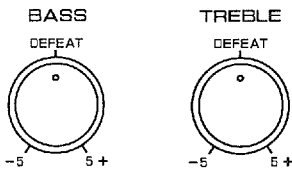

**BASS** : Turn this clockwise to increase (or counter-clockwise to decrease) the low frequency response.

**TREBLE** : Turn this clockwise to increase (or counter-clockwise to decrease) the high frequency response.

#### Note

These controls are effective only on the sound from the front speakers.

### Selecting the SPEAKER system

Because one or two speaker systems (as front speakers) can be connected to this unit, the **SPEAKERS** switches allow you to select speaker system A or B, or both at once.

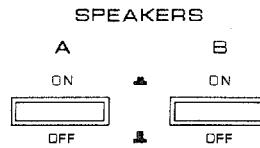

### Using the TONE-BYPASS switch

Press this switch to revert instantly to the flat states of the **BASS** and **TREBLE** controls without changing the setting of these controls.

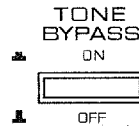

### Using the BASS EXTENSION switch

You can boost bass frequency response by setting this switch to the "ON" position. This switch is effective only on the sound from the front speakers.



### When you listen with headphones

Connect the headphones to the **PHONES** jack. The sound from the center and rear speakers will stop. However, the sound from the front speakers will be still output. When listening with headphones privately, set both the **SPEAKERS A** and **B** switches to the **OFF** position.

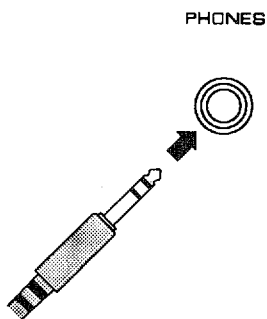

# TUNING OPERATIONS

Normally, if station signals are strong and there is no interference, quick automatic-search tuning is possible. However, if signals of the station you want to select are weak, you must tune to it manually.

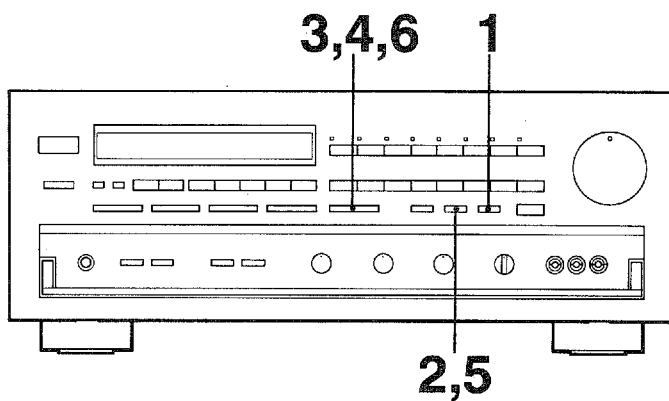

**1** Select the reception band (FM or AM) while watching the display.

**2** Press the TUNING MODE selector to start automatic search.

**3** Press the DOWN or UP tuning buttons to stop the search.

**4** If the station where tuning search stopped is not the desired one, press again.

**5** If the tuning search does not stop at the desired station; press the TUNING MODE selector to turn off "AUTO TUNING".

**6** Press the DOWN or UP tuning buttons to manually tune to the desired station.

\* You can tune to the desired station manually.

\* To continue tuning search, press and hold the button.

## Display information

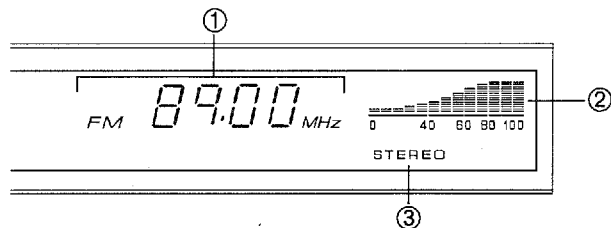

- ① Displays the band and frequency of the received station.
- ② Indicates the signal level of the received station.
- ③ Illuminates when an FM stereo broadcast with sufficient signal strength is received.

## Note

If you tune to a FM station manually, it is received in monaural automatically to increase the signal quality.



# PRESET TUNING

This unit can store station frequencies (selected by tuning operation) by using preset station buttons. With this function, you can select any desired station by only pressing the corresponding preset station button. Up to 40 stations (8 stations per page) can be programmed.

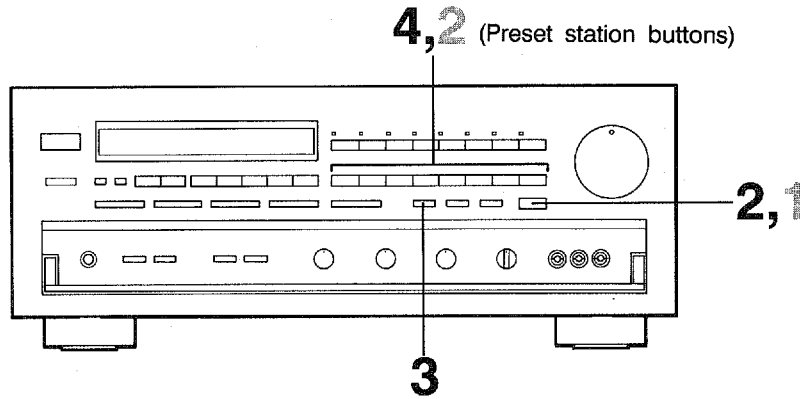

## To program stations

- 1 Tune to a desired station.  
(Refer to the previous page for tuning procedures.)
- 2 Select a desired page (A – E) of preset station buttons while watching the display.  
A/B/C/D/E
- 3   
Flashes on and off for about 5 seconds.
- 4   
Shows the displayed station has been programmed to A1.

\* In the same way, program other stations to A2, A3 ... A8.  
\* You can program more stations to the preset station buttons at other pages in the same way by selecting other pages in step 2.

## To recall a preset station

- 1 Select the page (A–E) of preset station buttons.  
A/B/C/D/E
- 2   
Select the desired one.

### Notes

- In step 4, press a preset station button before "MEMORY" goes off from the display.
- A new setting can be programmed in place of the former one.
- For presets, the setting of the reception mode (stereo or monaural) is stored along with the station frequency.

### Memory back-up

The memory back-up circuit prevents the programmed data from being lost even if the power is cut (for timer use or due to temporary power failure). If, however, the power is cut (because of disconnection of the AC power plug etc.) for more than two weeks, the memory may be erased. If so, it can be re-programmed by simply following the PRESET TUNING steps.

# USING DIGITAL SOUND FIELD PROCESSOR (DSP)

This unit incorporates a sophisticated, multi-program digital sound field processor, which allows you to expand and shape the audio sound field from both the audio and video sources, for a theater-like experience in the listening/viewing room. This digital sound field processor has 6 programs; 4 programs for digital sound field processing and 2 programs for the Dolby Pro Logic Surround sound system (**DOLBY PRO LOGIC** and **ENHANCED**). You can create excellent audio sound field by selecting the suitable program and adding desired adjustments. In addition, when the digital sound field program is in the **DOLBY PRO LOGIC** or **ENHANCED**, the built-in automatic input balance control functions. This presents you the best surround condition without adjusting it manually.

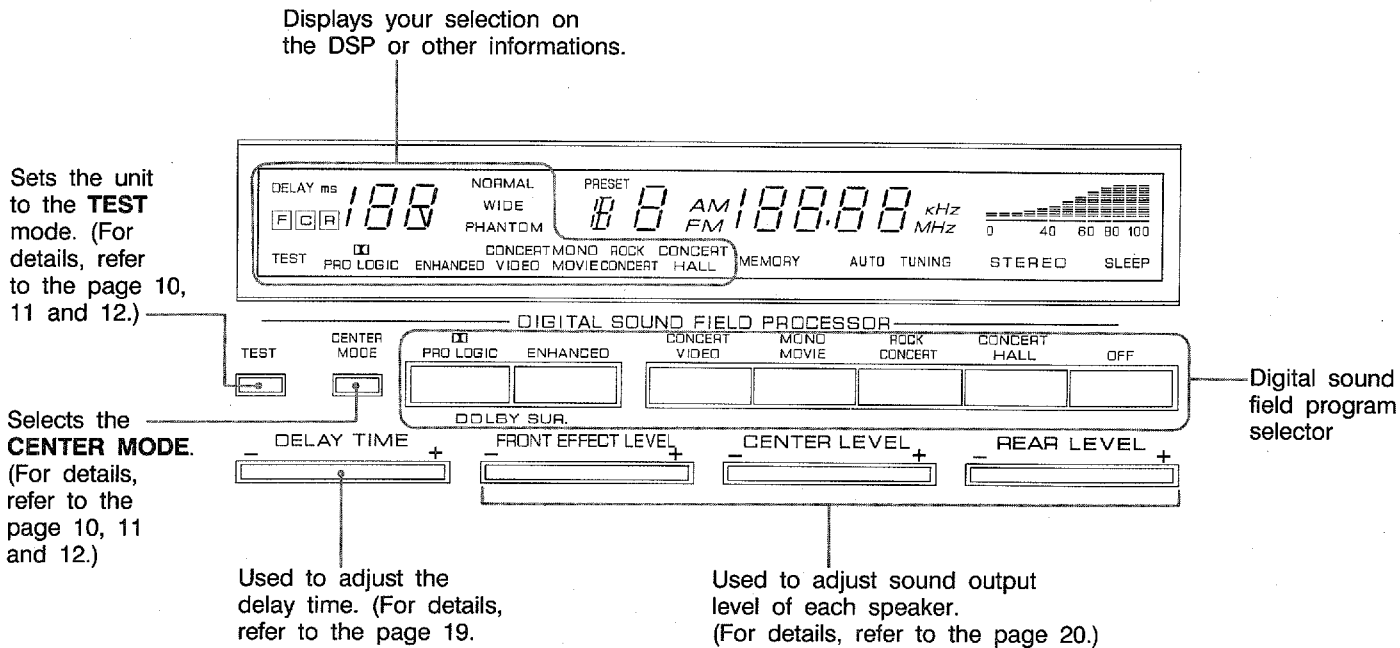

## Description of Each Sound Field Program

PROGRAM	FEATURE
<input checked="" type="checkbox"/> PRO LOGIC	This program is effective on the play of the sources encoded with the Dolby Surround. The employment of the digital signal processing system improves crosstalk and transfers the sound source more smoothly and precisely. A stable movie sound field is recreated.
ENHANCED	This program is effective on the play of the sources encoded with the Dolby Surround. Adding the features of the "Normal" Dolby Pro Logic, the DSP technology simulates the multi-surround speaker systems of the 35 mm film theater, so widening the surrounded-sound field with greater presence.
CONCERT VIDEO	This program is effective on music videos and excellent in depth and clarity for vocals. For opera, the orchestra and stage are ideally recreated, so letting you feel as if you were in an actual concert hall.
MONO MOVIE	This program is designed specifically to enhance mono source programs. Compared to a strictly mono setting, the sound image created in this mode is wider and slightly forward of the speaker pair, lending an immediacy to the overall sound. It is particularly effective when used with old mono movies, news broadcasts and dialogue.
ROCK CONCERT	This program will suit to rock music. A big, powerful sound is reproduced lively and dynamically.
CONCERT HALL	In this program, the center seems even more deeply behind the front speaker pair, creating an expansive, large hall ambience.

**OFF Switch :** When any program is not used with the selected source, press this switch. The sound is output only from the front speakers.

## Notes on Operation of Sound Field Programs

- In the **CONCERT VIDEO, MONO MOVIE, ROCK CONCERT** and **CONCERT HALL**, no sound is heard from the center speaker.
- When the monaural sound source is played in the **DOLBY PRO LOGIC** or **ENHANCED**, no sound is heard from the front speakers and the rear speakers. Sound is heard only from the center speaker. However, if the center mode is in the **PHANTOM**, the front speakers output the sound of the center speaker.
- If you connect an external amplifier to this unit, see if it has built-in surround sound or ambience circuitry. If it does, then be sure that the surround or ambience circuitry is off on the source amp while you are using the digital sound field processor's Dolby Pro Logic Surround decoding function.
- When this unit is in the Dolby Pro Logic Surround mode, if the main-source sound is considerably altered by overadjustment of the **BASS, TREBLE** controls or **BASS EXTENSION** switch, the relationship with the center and rear channels may produce an unnatural effect.

## Description of Dolby Pro Logic Surround

 **DOLBY PRO LOGIC SURROUND:** This unit employs the Dolby Pro Logic Surround system. This system is similar to professional Dolby Stereo decoders used in movie theaters.

The Dolby Pro Logic Surround system, by employing a four-channel system, divides the input signals into four levels: the left and right main channels, the center channel (to characterize dialogue), and the rear surround-sound channels (to characterize sound effects, background noise and other ambient noise).

Dolby Surround is encoded on the sound track of commercially available video cassettes and video discs as well. When you play a source encoded with Dolby Surround on your home video system, the Dolby Pro Logic Surround mode on this unit decodes the signal and feeds the surround-sound effects.

The Dolby Pro Logic Surround mode may not be always effective on video sources not encoded with Dolby Surround.

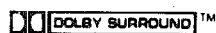

Manufactured under license from Dolby Laboratories Licensing Corporation. Additionally licensed under one or more of the following patents: U.S. numbers 3,632,886, 3,746,792, and 3,959,590; canadian numbers 1,004,603 and 1,037,877. "Dolby" and the double-D symbol are trademarks of Dolby Laboratories Licensing Corporation.

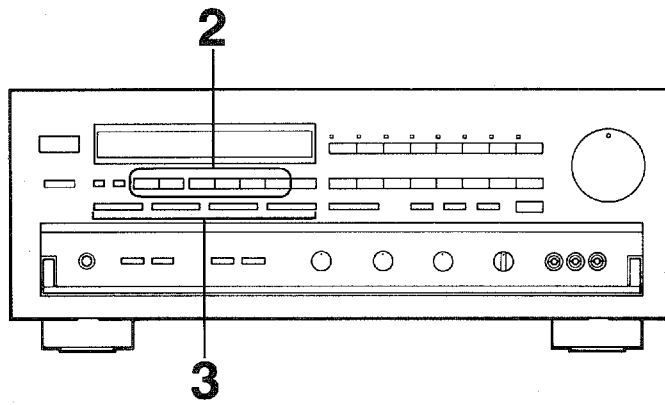

## To play source with the digital sound field processor

**1** Follow the step 1, 2, 3, 4, 5, and 6 shown in "OPERATION".

**2** Select a desired program suitable for the source.

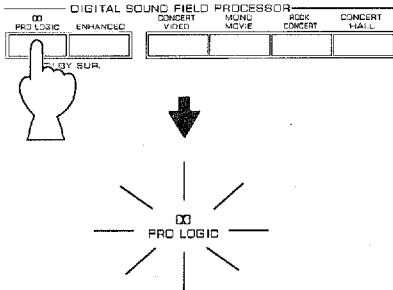

The corresponding indicator will illuminate.

**3** If desired, adjust the delay time and the output level of each speaker. (For details, refer to the corresponding descriptions on this page and the next page.)

### Note

If you prefer to cancel the selected program, press the **OFF** switch. The sound will be the normal 2-channel stereo without surround sound effect.

## Adjustment of DELAY TIME

You can adjust the time difference between the beginning of the source sound and the beginning of the effect sound with the **DELAY TIME** control.

The **DELAY TIME** control is effective with all programs. By applying more or less delay, sound effects, background noise, and ambient noise coming at you from the rear speakers can be enhanced or subdued for extra effect.

- 1 **PRO LOGIC**: from 15 to 30 milliseconds  
(Preset value: 20 milliseconds)
- 2 **ENHANCED**: from 15 to 30 milliseconds  
(Preset value: 20 milliseconds)
- 3 **CONCERT VIDEO**: from 1 to 100 milliseconds  
(Preset value: 25 milliseconds)
- 4 **MONO MOVIE**: from 1 to 100 milliseconds  
(Preset value: 25 milliseconds)
- 5 **ROCK CONCERT**: from 1 to 100 milliseconds  
(Preset value: 15 milliseconds)
- 6 **CONCERT HALL**: from 1 to 100 milliseconds  
(Preset value: 30 milliseconds)

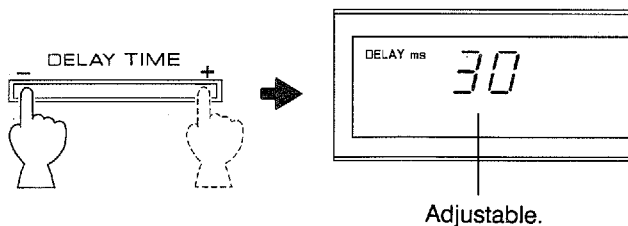

- By continuously pressing "+" or "-" of the **DELAY TIME** control, the value changes continuously. However, the value stops changing momentarily at the preset point.

### Note

Adding too much delay will cause an unnatural effect with some sources. Experiment with the **DELAY TIME** control to create an effect that you find most suitable.

## Adjustment of the FRONT EFFECT LEVEL

If desired, you can adjust the effect sound output level of the front speakers with this control. The output level is preset to be 80. However, you can adjust the level between 1 and 100.

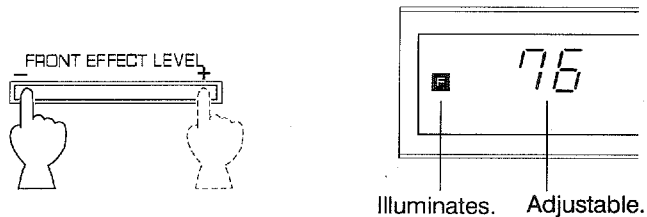

- If the digital sound field program is in the **DOLBY PRO LOGIC**, the **FRONT EFFECT LEVEL** control does not function.
- Once the output level is adjusted, the level value will be common among all the digital sound field programs except the **DOLBY PRO LOGIC**.
- If any digital sound field program is not used, the **FRONT EFFECT LEVEL** control does not function.

## Adjustment of the CENTER LEVEL

If desired, you can adjust the sound output level of the center speaker with this control even if the output level is already set in "**Speaker balance adjustment**" on the page 10.

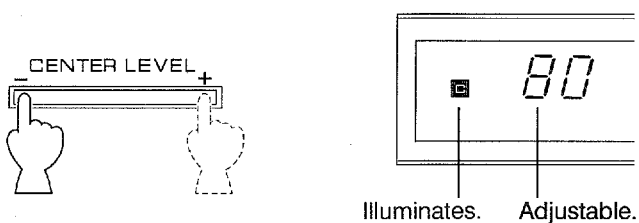

- By continuously pressing "+" or "-" of the **CENTER LEVEL** control, the level value changes continuously. However, the value stops changing momentarily at the point which was once set in the **TEST** mode.
- If the digital sound field program is in the **CONCERT VIDEO, MONO MOVIE, ROCK CONCERT** or **CONCERT HALL**, the **CENTER LEVEL** control can not function.
- Once the output level is adjusted, the level value will be common among the **DOLBY PRO LOGIC** and **ENHANCED**.
- If any digital sound field program is not used, the **CENTER LEVEL** control does not function.

## Adjustment of the REAR LEVEL

If desired, you can adjust the sound output level of the rear speakers with this control even if the output level is already set in "**Speaker balance adjustment**" on the page 10.

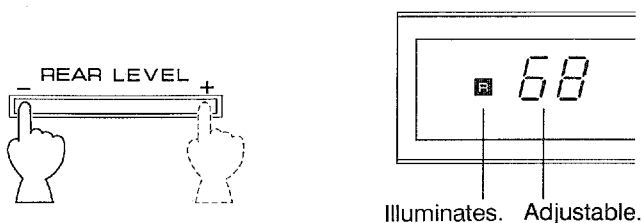

- By continuously pressing "+" or "-" of the **REAR LEVEL** control, the level value changes continuously. However, the value stops changing momentarily at the point which was once set in the **TEST** mode.
- Once the output level is adjusted, the level value will be common among all the digital sound field programs.
- If any digital sound field program is not used, the **REAR LEVEL** control does not function.

### Note

The values of the **DELAY TIME**, the **FRONT EFFECT LEVEL**, **CENTER LEVEL**, and **REAR LEVEL** you set the last time will remain memorized even when the power of this unit is off.

However, in case the power plug cord is kept disconnected for more than two weeks, these values will be invalid.

# SETTING OF THE SLEEP TIMER

If you use the **SLEEP** timer of this unit, you can set this unit to be turned off automatically. When you are going to sleep while enjoying a broadcast or other desired input source, this timer function is helpful.

**Note**

- The **SLEEP** timer can be controlled only with the remote-control transmitter.
- The components on which the **SLEEP** timer is effective are the sources connected to a **SWITCHED OUTLET** on the rear panel of this unit.

## To set the SLEEP time

**1**

Press repeatedly.

Indicates the **SLEEP** time. Changes on each press as follows.

Flashes on and off continuously.

(Minutes)

120 → 90 → 60 → 30

The indication before the **SLEEP** key is pressed. (The **SLEEP** timer is in the OFF state.)

**2** Select the desired value.

Turns to the indication before the **SLEEP** timer is activated.

Stops flashing and illuminates.

**3** The unit will be turned off automatically after the passing of the **SLEEP** time you selected.

## To cancel the selected SLEEP time

Press once when the **SLEEP** time displays 30.

# REMOTE-CONTROL TRANSMITTER

The provided remote-control transmitter is designed to control this unit and other YAMAHA components. If the CD player, turntable, LD player and tape deck connected to this unit are YAMAHA components designed for remote-control compatibility, then this remote-control transmitter will also control various functions of each component. Please consult YAMAHA dealer for information on which components are compatible with the remote-control transmitter. Moreover, this remote-control transmitter can learn various functions from other remote-control transmitters without losing the preset key functions. If you use this "learning" function, you will no more need so many remote-control transmitters to control various components to be used. For details, refer to the next page.

## Preset Key Functions

When you operate this unit and/or YAMAHA components with this remote-control transmitter, set the **RS-USER-LEARN** switch to the **RS** position.

### For Receiver Control

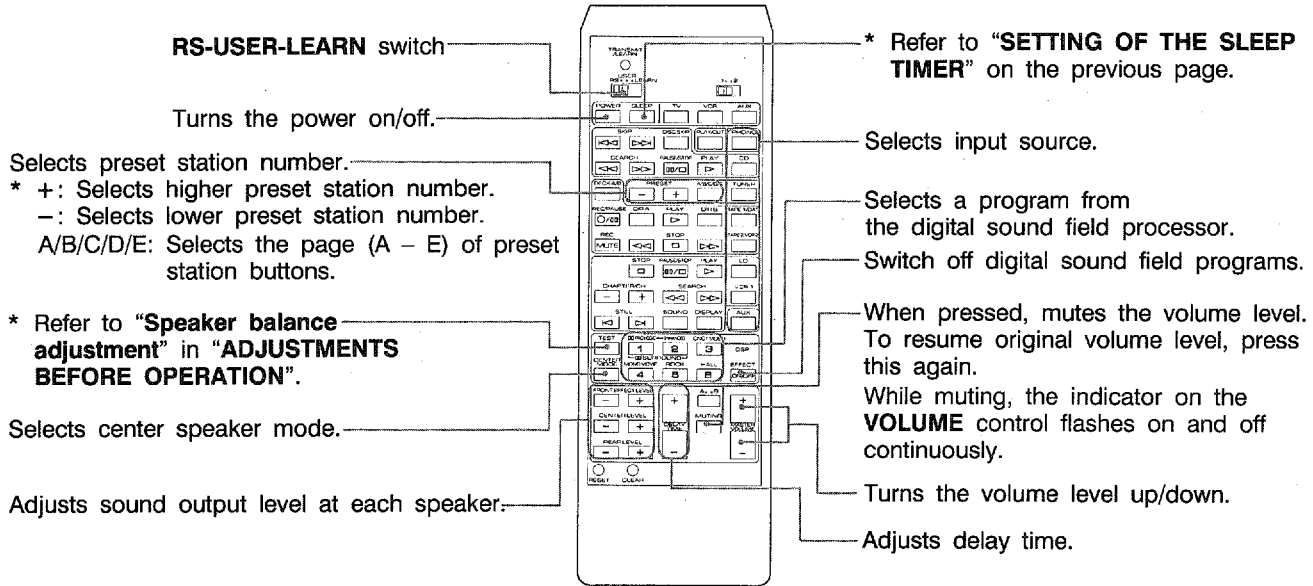

### For Other Component Control

Identify the remote-control transmitter keys with your component's keys. If these keys are identical, their function will be the same. On each key function, refer to the corresponding instruction on your component's manual.

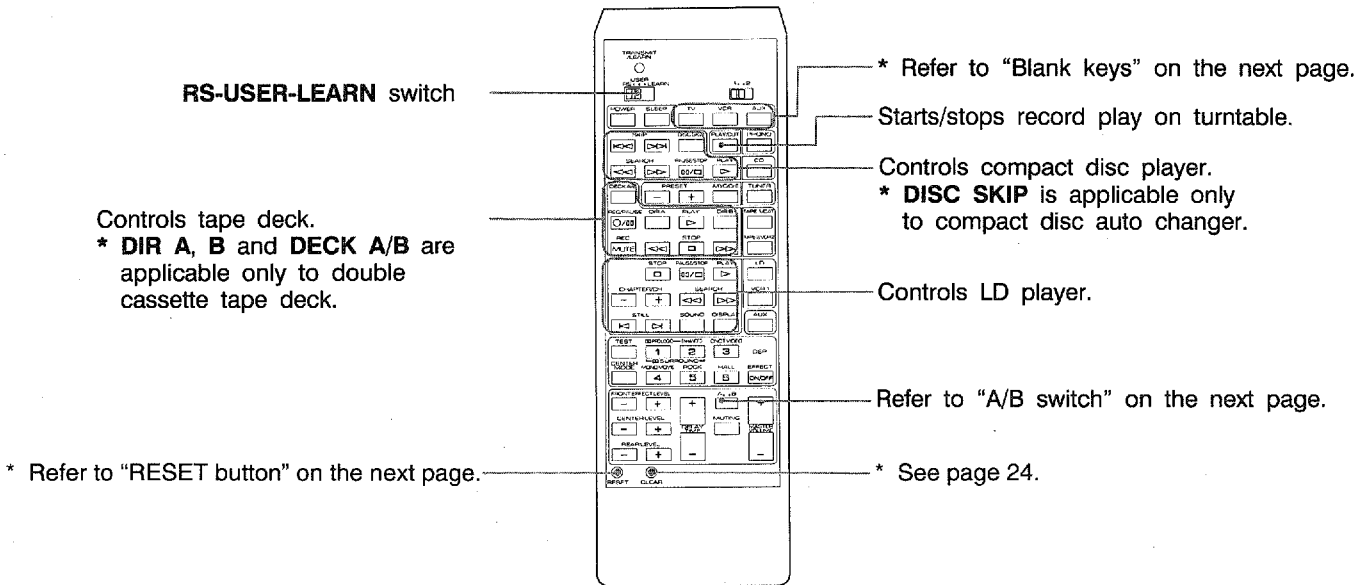







# REMOTE-CONTROL "LEARNING" FUNCTION

The keys on this remote-control transmitter can be programmed to "learn" key-functions from other remote-control transmitters. By using this feature, this unit can then be used in place of one or more other remote-control transmitters, thus making operation of your various audio and video components more convenient. Moreover, each key can learn two functions by switching the learning page. Use the included user program sheets to indicate a new function learned for each key.

**Note**

There may occasionally be instances in which, due to the signal-coding and modulation systems employed by the other remote-control transmitter, that this unit will not be able to "learn" its signals.

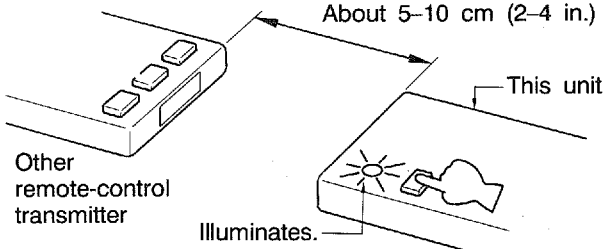
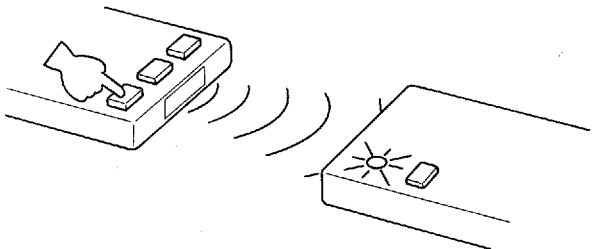
## To Learn a New Function

<b>1</b>	
	Set to a desired learning page.
<b>2</b>	
	Set to the "LEARN" position.
<b>3</b>	<p>Press a key on this unit where a new function will be learned.</p> 
<b>4</b>	<p>Press and hold the key (on the other remote-control transmitter) where the desired new function is.</p> 
	When the <b>TRANSMIT/LEARN</b> indicator stops illuminating, the learning is finished.
<b>5</b>	Repeat the step 3 and 4 until all desired functions are successfully learned.
<b>6</b>	<p>Set to the "USER" position.</p> 
	Try operating your components.

**Notes**

- When you operate the desired component with this remote-control transmitter, **TRANSMIT/LEARN** indicator will flash steadily.
- The originally preset function of a key is still available in the **USER** position if a new function has not been learned to the key.
- Successful learning to a key results in the erasure of previously learned functions and their replacement by the newly learned ones.
- If there is no more room in the memory area for a function to be learned, the **TRANSMIT/LEARN** indicator will flash two times. In this case, even if some keys are not occupied with functions from other remote-control transmitters, no further learning is possible.

**Memory back-up**

All of the learned functions will be retained while you replace the batteries. However, if no batteries are installed for a few hours, the learned functions will be erased and will have to be learned again.

**Blank keys (Refer to the previous page.)**

These keys have no preset functions and are used only for learning other remote-controllers' functions.

**1/2 switch (To switch the learning page)**

This switch changes the learning page (1 or 2) of the all the keys except the shaded keys shown below in "A/B switch".

**A/B switch (To switch the learning page)**

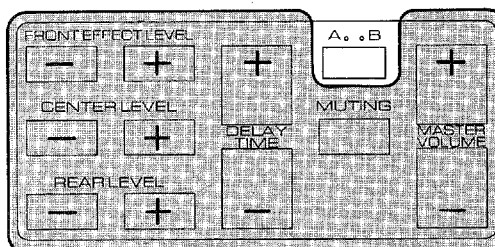

This switch changes the learning page (A or B) of the shaded keys shown below instead of the 1/2 switch.



**RESET button**

Press this button to "reset" the internal microcomputer which controls remote control operations. Microcomputer "reset" is necessary when the remote control freezes.

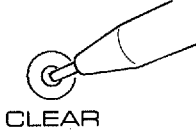

## To Clear a Learned Function

<b>1</b>	 <p>Set to the "USER" position.</p>
<b>2</b>	<p>Press and hold the <b>CLEAR</b> button using the point of a mechanical pencil, etc.</p>  <p style="text-align: center;">CLEAR</p>
<b>3</b>	<p>Press and hold the key where the learned function to be deleted is until the indicator flashes 3 times.</p>  <p>To clear two or more functions, repeat steps 2 and 3.</p>

### Note

If a key is not pressed soon after the **CLEAR** button is pressed, this unit will automatically return to the status that was in effect before the **CLEAR** button was pressed.

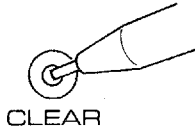
## To Clear All Learned Functions

<b>1</b>	 <p>Set to the "LEARN" position.</p>
<b>2</b>	<p>Press and hold the <b>CLEAR</b> button using the point of a mechanical pencil, etc.</p>  <p style="text-align: center;">CLEAR</p>
<b>3</b>	<p>Press and hold any key until the indicator flashes 7 times.</p> 

## NOTES ABOUT THE REMOTE CONTROL TRANSMITTER

### Battery installation

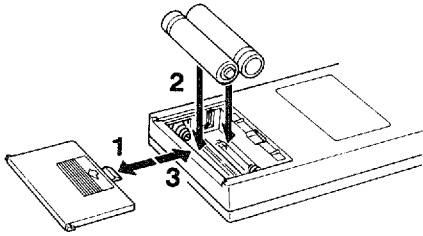

### Battery replacement

If the remote-control transmitter must be used closer to the main unit, the batteries are weak. Replace both batteries with new ones.

#### Notes

- "AA" (LR6) batteries should be used for replacement.
- Be sure the polarities are correct. (See the illustration inside the battery compartment.)
- Remove the batteries if the remote-control transmitter will not be used for an extended period of time.
- If batteries leak, immediately dispose of them. Avoid touching the leaked material or letting it come in contact with clothing, etc. Clean the battery compartment thoroughly before installing new batteries.

### Remote-control transmitter operation range

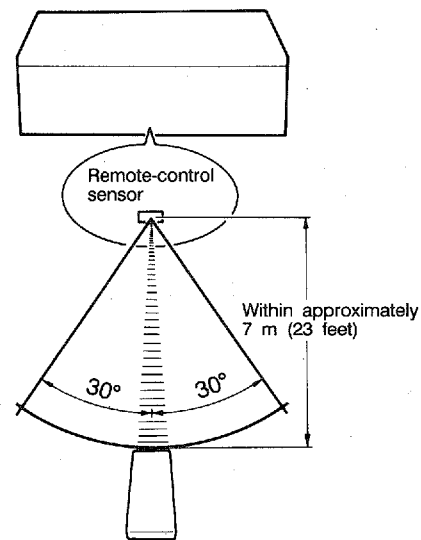

There should be no large obstacles between the remote-control transmitter and the main unit.

# TROUBLESHOOTING

If the unit fails to operate normally, check the following points to determine whether the fault can be corrected by the simple measures suggested. If it cannot be corrected, or if the fault is not listed in the SYMPTOM column, disconnect the power cord and contact your authorized YAMAHA dealer or service center for help.

	SYMPTOM	CAUSE	REMEDY
Amplifier	The unit fails to turn on when the POWER switch is pressed.	Power cord is not plugged in or is not completely inserted.	Firmly plug in the power cord.
	No sound or no picture.	Incorrect output cord connections.	Connect the cords properly. If the problem persists, the cords may be defective.
		The MUTING switch is ON.	First, turn the volume control to the full left. Then, turn the MUTING switch OFF with the remote control transmitter and adjust the volume.
		Appropriate input selector is not pressed.	Press the appropriate input selector corresponding to the input source.
	The sound suddenly goes off.	The protection circuit has activated because of short circuit etc.	Turning the unit off and then on will reset the protection circuit.
	Only one side speaker outputs the sound.	Incorrect setting of the BALANCE control	Adjust it to the appropriate position.
		Incorrect cord connection.	Connect cord properly. If the problem persists, the cables may be defective.
	Sound "hums".	Incorrect cord connections.	Firmly connect the audio plugs. If the problem persists, the cord may be defective.
		No connection from the turntable to the GND terminal.	Make the GND connection between the turntable and this unit.
	The volume level is low while playing a record.	The record is being played on a turntable with an MC cartridge.	The player should be connected to the receiver through the MC head amplifier.
	No sound from the rear speakers.	The sound output level of the rear speakers is 0.	Turn up the sound output level with the REAR LEVEL key.
		The monaural sound source is played in the DOLBY PRO LOGIC or ENHANCED.	Select another program suitable for the monaural sound source.
	No sound from the center speaker.	The sound output level of the center speaker is 0.	Turn up the sound output level with the CENTER LEVEL key.
		The center mode is in the PHANTOM.	Select the NORMAL or WIDE.
		Incorrect sound field program selection.	Select the appropriate program.
No sound field program is selected.			
FM	FM stereo reception is noisy.	Because of the characteristics of FM stereo broadcasts, this is limited to cases where the transmitter is too far or the antenna input is poor.	Check the antenna connections. Try using a multiple element FM antenna.
	There is distortion and clear reception cannot be obtained even with a good FM antenna.	There is multipath interference.	Adjust antenna placement to eliminate multipath interference.
	A desired station cannot be tuned in with Auto tuning.	The station is too weak.	Use Manual tuning mode. Use high quality directional FM antenna.
AM	A desired station cannot be tuned in with Auto tuning.	Weak signal or loose antenna connections.	Tighten the AM loop antenna connections and rotate it for best reception. Use Manual tuning mode.
	There are continuous crackling and hissing noises.	Noises will result from lightning, fluorescent lamps, motors, thermostats and other electrical equipment.	Use an outdoor antenna and a ground wire. This will help somewhat but it is difficult to eliminate all noise.
	There are buzzing and whining noises (especially in the evening).	A television set is being used nearby.	Move the television away.
Remote control transmitter	Learning can not be made successfully.	The batteries of the other remote control transmitter are weak. The distance between the two remote control transmitters is too long or too short.	Replace the batteries. Place the remote control transmitters with the proper distance.
	The remote control transmitter does not work.	Direct sunlight or lighting (of an inverter type of fluorescent lamp etc.) is striking the remote control sensor of the main unit.	Change position of the main unit.
	The remote control transmitter does not work even if the learning was successful.		
	The TRANSMIT/LEARN indicator does not illuminate or flash.	The batteries of this remote control transmitter are too weak.	Replace the batteries with new ones.
	The distance or range within which the remote control transmitter can be used decreases.		
Others	The sound is degraded when monitoring is performed by using the headphones connected to the compact disc player or cassette deck which are connected with this unit.	The power of this unit is OFF.	Switch the power ON.

# SPECIFICATIONS

## AUDIO SECTION

Minimum RMS Output Power per Channel	
Main (20 Hz - 20 kHz 0.015% THD 8Ω/6Ω)	110W/135W
Center (20 Hz - 20 kHz 0.015% THD 8Ω/6Ω)	110W/135W
Rear Effect (1 kHz 0.08% THD 8Ω/6Ω)	30W/40W
Dynamic Power per Channel (by IHF Dynamic Headroom measuring method)	
8/6 ohms	160W/190W
Dynamic Headroom	
8/6 ohms	1.6 dB/2.0 dB
Damping Factor	
8 ohms, 1 kHz	55
Input Sensitivity/Impedance	
PHONO MM	2.5 mV/47 k-ohms
CD/LD/AUX/TAPE/VCR	150 mV/47 k-ohms
MAIN IN	1V/47 k-ohms
Maximum Input Signal (1 kHz, 0.01% THD)	
PHONO MM	90 mV
Output Level/Impedance	
REC OUT	150 mV/470 ohms
PRE OUT	1V/3.3 k-ohms
LOW PASS	0.8V/3.9 k-ohms
Maximum Voltage Output (20 Hz to 20 kHz, 0.01% THD)	
PRE OUT	4.8 V
Headphone Jack Rated Output/Impedance	
Output Level, 0.01% THD 1kHz RL=8 ohms	0.6V
Impedance	390 ohms
Frequency Response (20 Hz to 20 kHz)	
CD/LD/AUX/TAPE/VCR	0±1.5 dB
MAIN IN	0±0.3 dB
RIAA Equalization Deviation	
PHONO MM	±0.5 dB
Total Harmonic Distortion (20 Hz to 20 kHz)	
PHONO MM to REC OUT (1V)	0.01%
CD/LD/AUX/TAPE/VCR to PRE OUT (1V)	0.008%
MAIN IN to SP OUT (50W/8 ohms)	0.008%
(60W/6 ohms)	0.008%
Signal-to-Noise Ratio (IHF-A Network)	
PHONO MM (5 mV Input Shorted)	More than 86 dB
CD/LD/AUX/TAPE/VCR (Shorted)	More than 93 dB
Residual Noise (IHF-A Network)	
	150 μV
Channel Separation (Vol. -30 dB)	

PHONO MM (Input Shorted 1 kHz/10 kHz)	
	65 dB/45 dB
CD/LD/AUX/TAPE/VCR (Input 5.1 k-ohms Terminated 1 kHz/10 kHz)	
	65 dB/45 dB
Tone Control Characteristics	
BASS: Boost/cut	±10 dB (50 Hz)
Turnover Frequency	350 Hz
TREBLE: Boost/cut	±10 dB (20 kHz)
Turnover Frequency	3.5 kHz
BASS EXTENSION	+7 dB (50 Hz)
Audio Muting	-∞

## VIDEO

Video Signal Type	
[U.S.A. and Canada models]	NTSC
[Australia model]	PAL
[General Model]	NTSC/PAL
Video Signal Level	1 Vp-p/75Ω
S-Video Signal Level	
Y	1 Vp-p/75Ω
C	0.286 Vp-p/75Ω
Maximum Input Level	More than 1.5 Vp-p
Signal-to-Noise Ratio	50 dB
Frequency Response	5 - 10 MHz, -3 dB

## FM SECTION

Tuning Range	
[U.S.A. and Canada models]	87.5 to 107.9 MHz
[Australia and General models]	87.5 to 108 MHz
50 dB Quieting Sensitivity (IHF, 75 ohms)	
Mono	1.55 μV (15.1 dBf)
Stereo	21 μV (37.7 dBf)
Usable Sensitivity (75 ohms) (30 dB S/N Quieting, 1 kHz, 100% mod.)	
	0.8 μV (9.3 dBf)
Image Response Ratio	45 dB
IF Response Ratio	80 dB
Spurious Response Ratio	70 dB
AM Suppression Ratio	55 dB
Capture Ratio	1.5 dB
Alternate Channel Selectivity	85 dB
Signal-to-Noise Ratio (IHF) Mono/Stereo	
	81 dB/76 dB
Harmonic Distortion (1 kHz)	
Mono/Stereo	0.1%/0.2%
Stereo Separation (1 kHz)	
	50 dB
Frequency Response	
20 Hz to 15 kHz	0±1.5 dB

## AM SECTION

Tuning Range	
[U.S.A., Canada and General models]	530 to 1,710 kHz
[Australia and General models]	531 to 1,611 kHz
Usable Sensitivity	100 μV/m
Selectivity	32 dB
Signal-to-Noise Ratio	50 dB
Image Response Ratio	40 dB
Spurious Response Ratio	50 dB
Harmonic Distortion	0.3%

## AUDIO SECTION

Output Level/Impedance	
FM (100% mod., 1 kHz)	700 mV/470 ohms
AM (30% mod., 400 Hz)	200 mV/470 ohms

## GENERAL

Power Supply	
[U.S.A. and Canada models]	AC 120V, 60 Hz
[Australia model]	AC 240V, 50 Hz
[General model]	AC 110/120/220/240V, 60/50 Hz
Power Consumption	
[U.S.A., Australia and General models]	400W
[Canada model]	750 VA/600W
AC Outlets	
[U.S.A. and General models]	
2 SWITCHED OUTLETS	100W max. total
1 UNSWITCHED OUTLET	200W max. total
[Canada model]	
2 SWITCHED OUTLETS	120W max. total
1 UNSWITCHED OUTLET	180W max. total
[Australia model]	
1 SWITCHED OUTLET	100W max. total
Dimensions (W x H x D)	
	435 x 171.5 x 468.5 mm (17-1/8" x 6-3/4" x 18-7/16")
Weight	18.6 kg (40 lbs. 15 oz.)
Accessories	
	AM loop antenna
	Indoor FM antenna
	Remote control transmitter
	Batteries
	User program sheets
[Australia model only]	75-ohm/300-ohm antenna adapter

Specifications subject to change without notice.



# YAMAHA

---

YAMAHA ELECTRONICS CORPORATION USA 8660 ORANGETHORPE AVE., BUENA PARK, CALIF. 90620, U.S.A.  
YAMAHA CANADA MUSIC LTD. 135 MILNER AVE., SCARBOROUGH, ONTARIO M1S 3R1, CANADA  
YAMAHA ELECTRONIK EUROPA G.m.b.H. SIEMENSSTR. 22-34, D-2084 RELINGEN BEI HAMBURG, F.R. OF GERMANY  
YAMAHA ELECTRONIQUE FRANCE S.A. 17 RUE DES CAMPANULES, LOGNES 77321 MARNE LA VALLEE CEDEX 2, FRANCE  
YAMAHA ELECTRONICS (UK) LTD. YAMAHA HOUSE, 200 RICKMANSWORTH ROAD WATFORD, HERTS WD1 7JS, ENGLAND  
YAMAHA SCANDINAVIA A.B. J A WETTERGRENS GATA 1, BOX 30063, 400 43 VÄSTRA FRÖLUNDA, SWEDEN  
YAMAHA MUSIC AUSTRALIA PTY, LTD. 17-33 MARKET ST., SOUTH MELBOURNE, 3205 VIC., AUSTRALIA

YAMAHA CORPORATION  
VK20210-I BWWR,b   Printed in Japan